

MADEL®



## WAAB 300

### Active chilled beam – width 300



MADEL®

The **WAAB-300** chilled beam is an air/water induction terminal unit that simultaneously provides the supply, thermal treatment and diffusion of supply air, to set internal conditions at the desired comfort levels. Chilled beams take advantage of the excellent thermal properties of water to guarantee optimal comfort levels, with minimal power consumption.

The main heat-transferring component in the **WAAB-300** chilled beam is a battery, formed by copper tubing and aluminium blades. It also incorporates air ducts and a plenum for supplying the ventilation air, which has been pre-treated in a central air conditioning unit. The **WAAB-300** chilled beam can be supplied with connections on the side or on the top, for both supply air and return air.

The unit can be adapted to medium panel modular ceilings with T24 and T15 profiles. Thanks to its reduced size, it can also be installed in low-hanging false ceilings.

### WAAB-300

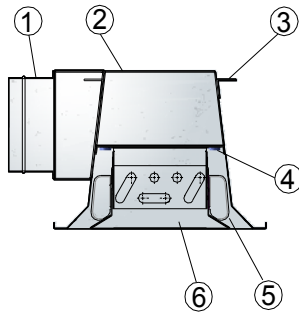

- 1.-Air input neck
- 2.-Plenum
- 3.-Anchoring point for fixing
- 4.-Nozzles
- 5.-Adjustable deflector
- 6.-Collapsible front panel

WAAB-300 /.../... /L /...

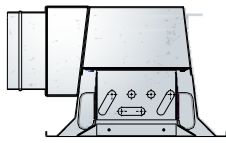

WAAB-300 /.../... /S /...

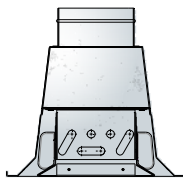

WAAB-300 / 2T /...

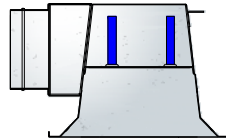

WAAB-300 / 4T /...

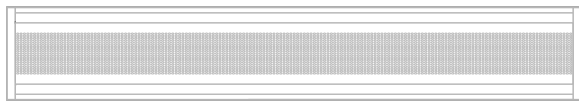
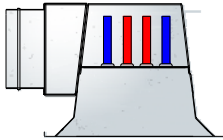

.../FC/



.../FQ/



.../FL/



.../T15/ .../T24/

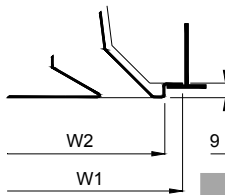

.../ /

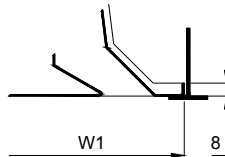

W <sub>N</sub>	/ /	/T15/		/T24/	
	W <sub>1</sub>	W <sub>1</sub>	W <sub>2</sub>	W <sub>1</sub>	W <sub>2</sub>
300	295	295	279	295	271
310	305	305	289	305	281
335	330	330	314	330	306

### CLASSIFICATION

- WAAB-300** Beam for supply air.
- .../2T/ 2-tube battery
- .../4T/ 4-tube battery.
- .../LD/ Right side connection.
- .../LI/ Left side connection.
- .../S/ Top connection.
- .../T15/ Support for dropped panel, 15-mm profile modular ceilings.
- .../T24/ Support for dropped panel, 24-mm profile modular ceilings.
- .../KS/ Small discharge nozzles.
- .../KM/ Medium discharge nozzles.
- .../KL/ Large discharge nozzles.
- .../FC/ Front panel with circular perforations.
- .../FQ/ Front panel with square perforations
- .../FL/ Front panel with lineal aluminium grill.
- .../TY/ Type (see pages 5,6 and 7)

### ACCESSORIES

**DEF** Deflecting blades(see page 4)

### FIXING

**(D)** Angle bracket for suspending from ceiling (see page 8)

### FINISH

- M9016** Lacquered white similar to RAL 9016
- R9010** Lacquered white RAL 9010
- RAL...** Lacquered other colours RAL

### MATERIAL

Galvanised steel body, ABS plastic deflective blades and battery with copper tubing and aluminium blades.  
The tubes connected to the battery have a diameter of 12 mm and a thickness of 1mm, in fulfilment of the EN 1057:1996 European Standard. The battery's maximum working pressure is 1 MPa.

### SPECIFICATION TEXT

Supply and installation of active chilled beam for supply air and return air, with 4-tube battery, right side connection plenum, pre-set medium nozzles, circular perforated front panel, type **LDR1**, with deflective blades, **WAAB-300 / 4T / LD / KM / FC / LDR1 1195x900 /+ DEF** Built in lacquered white galvanised steel **R9010**. Brand **MADEL**

**CONSTRUCTION AND WORKING SYSTEM**

**WAAB 300**

The ventilation air is injected through nozzles that cause the air to accelerate and force air induction in the room, through the battery. Subsequently, the two masses of air (the induced air and ventilation air) are supplied to the space that requires air-conditioning.

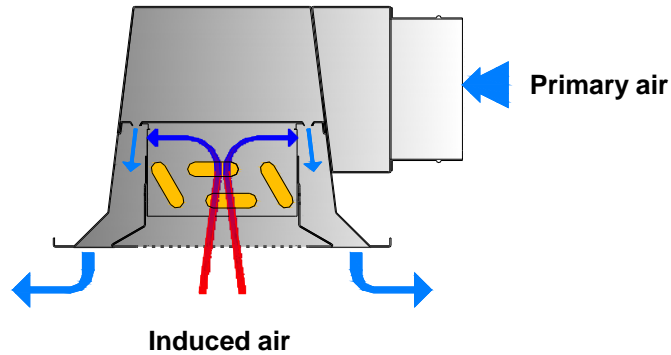

The **WAAB 300** has been designed so that it can be accessed easily for maintenance and servicing operations. For this, it has 4 fastening hinges, which keep the internal frame in position. Thus, the internal frame is collapsible over two axes, by simply moving the two hinges situated on the same face as the internal frame. In this way, both the battery and the primary airflow regulating systems are easily accessible for any necessary maintenance and adjustment operations. Plus, once the internal frame has been collapsed over one of its axes, the internal frame can be completely removed by moving the two remaining hinges.



Once the internal frame of the **WAAB 300** chilled beam has been released, the airflow can be adjusted and the deflection angle changed.

**Airflow adjustment**

The **WAAB 300** chilled beam can be supplied with a primary airflow adjustment system. This system can be used to select between three different air output configurations. Thus, even if the project specifications change, the primary airflow can still be readjusted using the same installation.

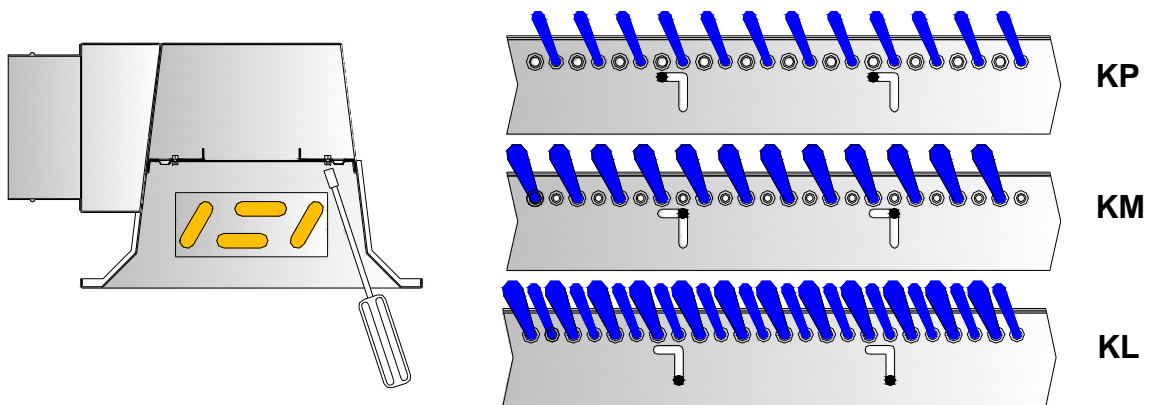

**Modification of the air deflection angle.**

The **WAAB 300** chilled beam can be supplied with air deflectors situated over the internal frame. The deflectors can be adjusted individually over a range of 0 to 45 °, permitting a wide variety of different air diffusion configurations in the treated area.

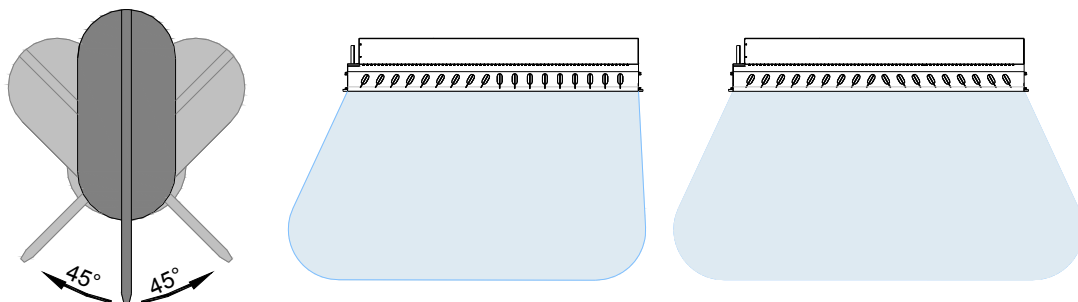



**TYPES AND DIMENSIONS**

**WAAB 300**

 Circular side supply air connection.

 Circular side return air connection

 Cold water connection.  
 Hot water connection.

 Circular top supply air connection.

 Circular top return air connection.

*Left side.*

LI

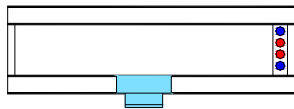

LIR1

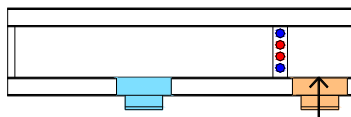

LIR2

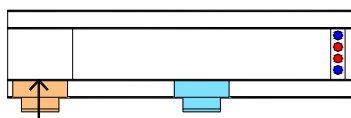

LIR3



LIR4

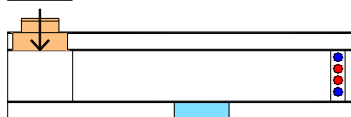

*Right side.*

LD

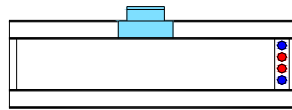

LDR1

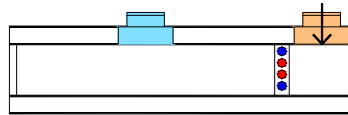

LDR2

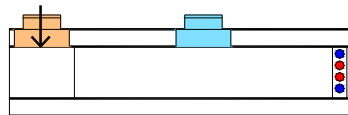

LDR3

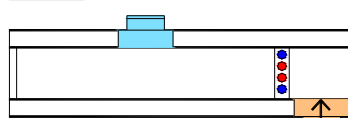

LDR4

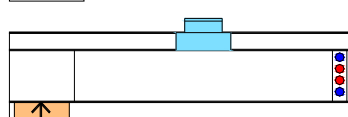

*Top.*

S

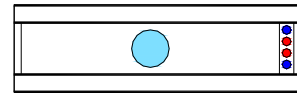

SR1

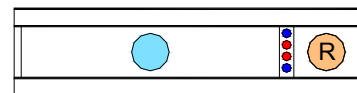

SR2

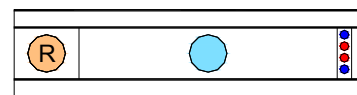

The typological definition should indicate the type of configuration, followed by the nominal length ( $L_N$ ) and the total length ( $L_1$ ).

*E.g. : LIR1  $L_1 \times L_N$  mm*

$L_1 = 895 \dots 2995$  mm

$L_N$  may only be supplied in standard lengths

**TYPES AND DIMENSIONS**

**WAAB 300**

LI, LD, S  
LN = 900, 1200, 1500, 1800

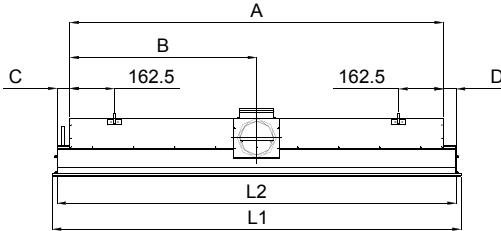

LI, LD, S  
LN = 2100, 2400, 2700, 3000

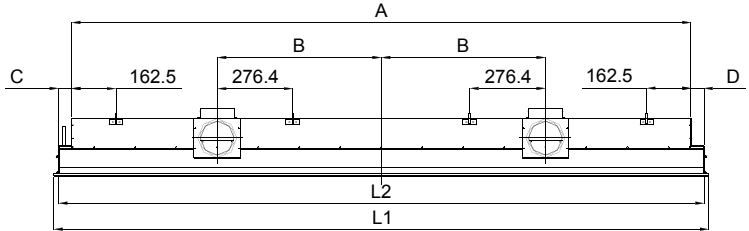

LIR1, LDR1, LIR3, LDR3, SR1  
LN = 900, 1200, 1500, 1800

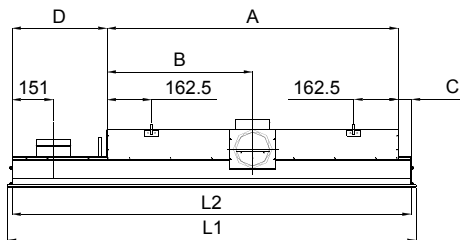

LIR1, LDR1, LIR3, LDR3, SR1  
LN = 2100, 2400, 2700

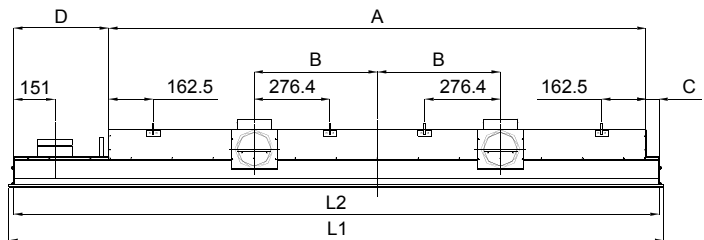

LIR2, LDR2, LIR4, LDR4, SR2  
LN = 900, 1200, 1500, 1800

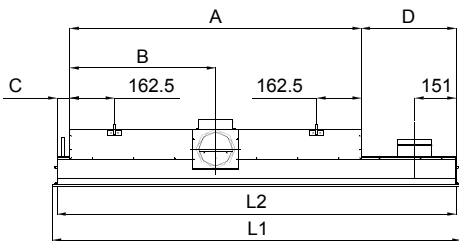

LIR2, LDR2, LIR4, LDR4, SR2  
LN = 2100, 2400, 2700

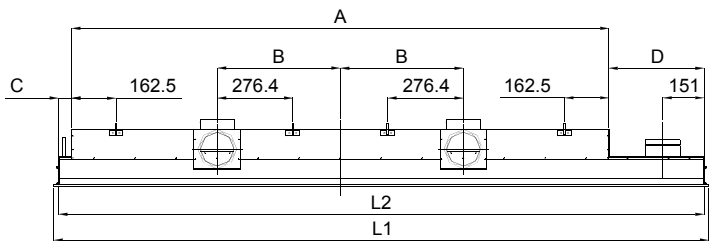

Configuration with side connection

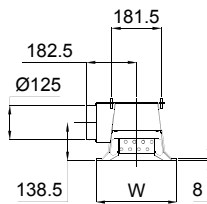

Configuration with upper connection

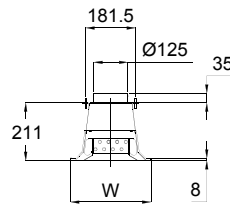

**1.- WAAB 300 - LI, LD,S**

LI, LD, S											
L <sub>1</sub> (mm)		L <sub>N</sub> (mm)	W (mm)	L <sub>2</sub> (mm)		A (mm)	B (mm)	C (mm)	D (mm)		φ (mm)
min	max			min	max				min	max	
895	2995	900	295	860	2960	765,5	382,8	47,3	47,3	2147,2	1-125
1195	2995	1200	295	1160	2960	1065,5	532,8	47,3	47,3	1847,2	1-125
1495	2995	1500	295	1460	2960	1365,5	682,8	47,3	47,3	1547,2	1-125
1795	2995	1800	295	1760	2960	1665,5	832,8	47,3	47,3	1247,2	1-125
2095	2995	2100	295	2060	2960	1965,5	450	47,3	47,3	947,2	2-125
2395	2995	2400	295	2360	2960	2265,5	600	47,3	47,3	647,2	2-125
2695	2995	2700	295	2660	2960	2565,5	750	47,3	47,3	47,3	2-125
2995	2995	3000	295	2960	2960	2865,5	900	47,3	47,3	47,3	2-125

2.- WAAB 300 – LIR, LDR

LIR1 , LIR2 , LIR3 , LIR4 , LDR1 , LDR2 , LDR3 , LDR4 , SR1 , SR2											
L <sub>1</sub> (mm)		L <sub>N</sub> (mm)	W (mm)	L <sub>2</sub> (mm)		A (mm)	B (mm)	C (mm)	D (mm)		φ (mm)
min	max			min	max				min	max	
1195	2995	900	295	1160	2960	765,5	382,8	47,3	347,2	1847,2	1-125
1495	2995	1200	295	1460	2960	1065,5	532,8	47,3	347,2	1547,2	1-125
1795	2995	1500	295	1760	2960	1365,5	682,8	47,3	347,2	1247,2	1-125
2095	2995	1800	295	2060	2960	1665,5	832,8	47,3	347,2	947,2	1-125
2395	2995	2100	295	2360	2960	1965,5	450	47,3	347,2	647,2	2-125
2695	2995	2400	295	2660	2960	2265,5	600	47,3	347,2	347,2	2-125
2995	2995	2700	295	2960	2960	2565,5	750	47,3	347,2	347,2	2-125

3.- WAAB 310 - LI, LD, S

LI , LD, S											
L <sub>1</sub> (mm)		L <sub>N</sub> (mm)	W (mm)	L <sub>2</sub> (mm)		A (mm)	B (mm)	C (mm)	D (mm)		φ (mm)
min	max			min	max				min	max	
932	2807	937	305	887	2762	765,5	382,8	60,8	60,8	1935,8	1-125
1245	2807	1250	305	1200	2762	1065,5	532,8	67,3	67,3	1629,3	1-125
1557	2807	1562	305	1512	2762	1365,5	682,8	73,3	73,3	1323,3	1-125
1870	2807	1875	305	1825	2762	1665,5	832,8	79,8	79,8	1016,8	1-125
2182	2807	2187	305	2137	2762	1965,5	450	85,8	85,8	710,8	2-125
2495	2807	2500	305	2450	2762	2265,5	600	92,3	92,3	404,3	2-125
2807	2807	2812	305	2762	2762	2565,5	750	98,3	98,3	98,3	2-125

4.- WAAB 310 – LIR, LDR

LIR1 , LIR2 , LIR3 , LIR4 , LDR1 , LDR2 , LDR3 , LDR4 , SR1 , SR2											
L <sub>1</sub> (mm)		L <sub>N</sub> (mm)	W (mm)	L <sub>2</sub> (mm)		A (mm)	B (mm)	C (mm)	D (mm)		φ (mm)
min	max			min	max				min	max	
1245	2807	937	305	1200	2762	765,5	382,8	60,8	373,8	1935,8	1-125
1557	2807	1250	305	1512	2762	1065,5	532,8	67,3	379,3	1629,3	1-125
1870	2807	1562	305	1825	2762	1365,5	682,8	73,3	386,3	1323,3	1-125
2182	2807	1875	305	2137	2762	1665,5	832,8	79,8	391,8	1016,8	1-125
2495	2807	2187	305	2450	2762	1965,5	450	85,8	398,8	710,8	2-125
2807	2807	2500	305	2762	2762	2265,5	600	92,3	404,3	404,3	2-125

5.- WAAB 335 - LI, LD, S

LI , LD, S											
L <sub>1</sub> (mm)		L <sub>N</sub> (mm)	W (mm)	L <sub>2</sub> (mm)		A (mm)	B (mm)	C (mm)	D (mm)		φ (mm)
min	max			min	max				min	max	
1007	2695	1012	330	937	2625	765,5	382,8	85,8	85,8	1773,8	1-125
1345	2695	1350	330	1275	2625	1065,5	532,8	104,8	104,8	1454,8	1-125
1682	2695	1687	330	1612	2625	1365,5	682,8	123,3	123,3	1136,3	1-125
2020	2695	2025	330	1950	2625	1665,5	832,8	142,3	142,3	817,3	1-125
2357	2695	2362	330	2287	2625	1965,5	450	160,8	160,8	498,8	2-125
2695	2695	2700	330	2625	2625	2265,5	600	179,8	179,8	179,8	2-125

6.- WAAB 335 –LIR, LDR

LIR1 , LIR2 , LIR3 , LIR4 , LDR1 , LDR2 , LDR3 , LDR4 , SR1 , SR2											
L <sub>1</sub> (mm)		L <sub>N</sub> (mm)	W (mm)	L <sub>2</sub> (mm)		A (mm)	B (mm)	C (mm)	D (mm)		φ (mm)
min	max			min	max				min	max	
1345	2995	1012	330	1275	2625	765,5	382,8	85,8	423,8	1773,8	1-125
1682	2995	1350	330	1612	2625	1065,5	532,8	104,8	441,8	1454,8	1-125
2020	2995	1687	330	1950	2625	1365,5	682,8	123,3	461,3	1136,3	1-125
2357	2995	2025	330	2287	2625	1665,5	832,8	142,3	479,3	817,3	1-125
2695	2995	2362	330	2625	2625	1965,5	450	160,8	498,8	498,8	2-125

The **WAAB 300** chilled beam incorporates a series of mounting angle brackets on both sides. These brackets have an 18-mm long slot, so that the chilled beam can be easily mounted in the installation. The number of brackets available varies depending on the nominal length of the selected chilled beam; 4 for  $L_N \leq 1800$  mm and 8 for  $L_N \geq 2100$  mm. The unit should be suspended from the structure with officially approved steel supports, cables or rods. Once suspended, the primary air duct should be connected to the plenum's neck. Likewise, the battery should be connected with solid elements, welding or quick connect fittings. Check that the hydraulic circuit has been properly emptied and that the beam is properly connected to the ventilation system to prevent air leaks.

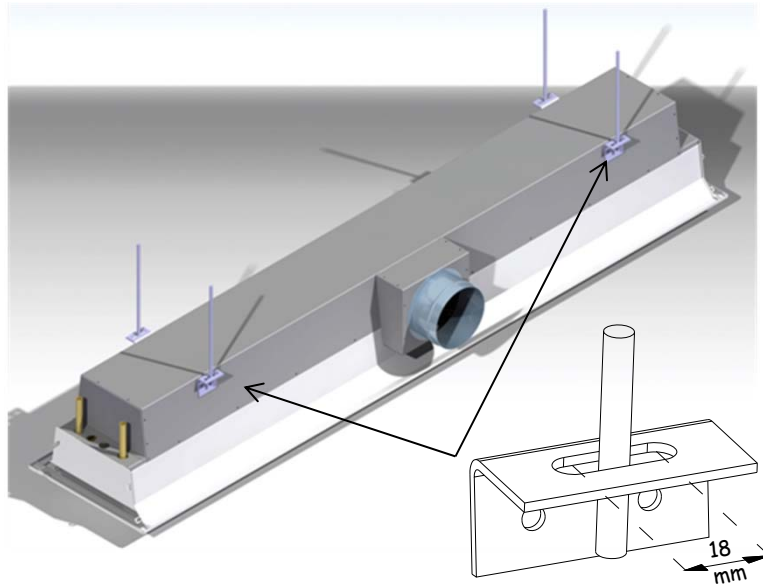

WAAB-.../ /

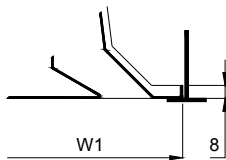

$W_N$	/ /	/T15/		/T24/	
	E	E	F	E	F
300	295	295	279	295	271
310	305	305	289	305	281
335	330	330	314	330	306

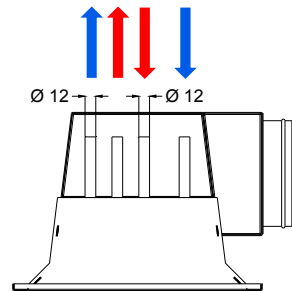

WAAB-.../ T15 /

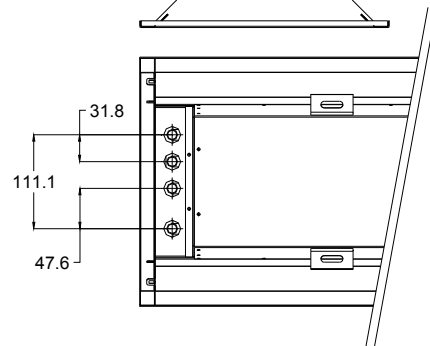
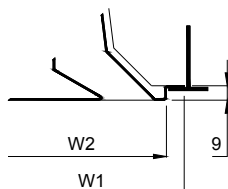

WAAB-.../ T24 /

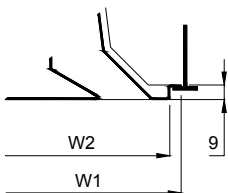



## DEFINITIONS

WAAB 300

Determining the performance/characteristics of chilled beams properly requires the performance of both thermal and diffusion tests, based on the benchmarks of standards EN 15116, EN 13182 and EN 14240.

For technical product selection uses software selection MADEL:

<http://www.madel.com/en/downloads-en/>

The benchmark is as follows:

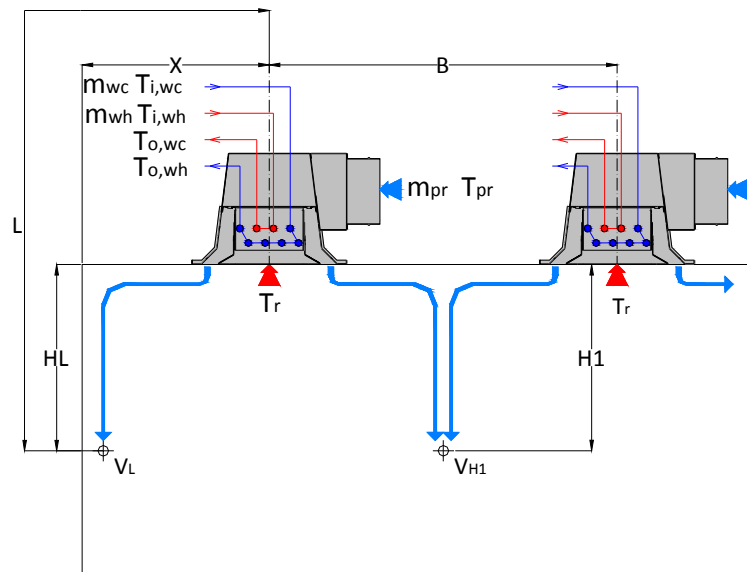
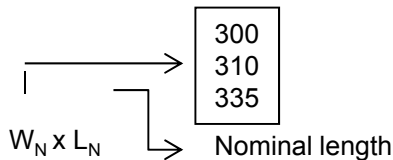

$V_{H1}$	(m/s)	Air speed at $H_1$ height
$V_L$	(m/s)	Air speed at $L$ height
$H_1$	(m)	Distance from ceiling to living area (1.8 m)
$B$	(m)	Distance between two chilled beams
$L_N$	(m)	Nominal length of chilled beam
$L_{WA}$	(dBA)	Sound power level
$P$	(W)	Total power ( $P=P_{pr} + P_{w,r}$ )
$P_{pr}$	(W)	Primary airflow rate
$P_w$	(W)	Nominal water cooling or heating power
$P_{w,r}$	(W)	Water cooling or heating power
$m_{pr}$	( $m^3/h$ )	Primary airflow volume
$m_{wh}$	(l/h)	Hot water flow volume
$m_{wc}$	(l/h)	Cold water flow volume
$T_{pr}$	( $^{\circ}C$ )	Primary air temperature
$T_R$	( $^{\circ}C$ )	Premises benchmark temperature
$T_{i,wc}$	( $^{\circ}C$ )	Cold water temperature at battery input
$T_{o,wc}$	( $^{\circ}C$ )	Cold water temperature at battery output
$T_{i,wh}$	( $^{\circ}C$ )	Hot water temperature at battery input
$T_{o,wh}$	( $^{\circ}C$ )	Hot water temperature at battery output
$P_a$	(Pa)	Static pressure inside plenum
$\Delta P_w$	(kPa)	Pressure drop in water circuit
$\Delta t_{aw}$	( $^{\circ}C$ )	Difference in premises benchmark temperature and supply water temperature ( $\Delta t_{aw}= T_R - T_{i,w}$ )
$\Delta t_{pr}$	( $^{\circ}C$ )	Difference in premises benchmark temperature and primary supply air temp. ( $\Delta t_{pr}= T_R - T_{pr}$ )
$F_w$		Correction factor of water rate based on water flow volume ( $P_{w,r}=P_w \cdot F_w$ )
$\Delta t_w$	( $^{\circ}C$ )	$^{\circ}C$ Thermal gradient in battery

The nominal working conditions for WAAB 300 chilled beams are as follows:

Cooling 2 and 4 tubes		Heating 2 tubes		Heating 4 tubes	
$T_R=$	26 $^{\circ}C$	$T_R=$	22 $^{\circ}C$	$T_R=$	22 $^{\circ}C$
$m_{wc}=$	110 l/h ( $L_N$ 900 a 1800) <sup>(1)</sup>	$m_{wh}=$	110 l/h ( $L_N$ 900 a 1800)	$m_{wh}=$	50 l/h ( $L_N$ 900 a 1800)
$m_{wc}=$	220 l/h ( $L_N$ 1800 a 2700) <sup>(1)</sup>	$m_{wh}=$	220 l/h ( $L_N$ 1800 a 2700)	$m_{wh}=$	110 l/h ( $L_N$ 1800 a 2700)
$T_{i,wc}=$	16 $^{\circ}C$ <sup>(2)</sup>	$T_{i,wh}=$	40 $^{\circ}C$ <sup>(3)</sup>	$T_{i,wh}=$	40 $^{\circ}C$ <sup>(3)</sup>
$T_{pr}=$	16 $^{\circ}C$	$T_{pr}=$	22 $^{\circ}C$	$T_{pr}=$	22 $^{\circ}C$

<sup>(1)</sup> The recommended flow volume will maintain a thermal gradient of 2-4  $^{\circ}C$  in the battery.

<sup>(2)</sup> We recommend using a supply water temperature of 14-16  $^{\circ}C$  to avoid condensation.

<sup>(3)</sup> We recommend using a supply water temperature of 35-40  $^{\circ}C$  to avoid air stratification.